

# HOW-TO INSTALL

## POOL COPING



**UNILOCK**  
PAVERS & WALLS

# HOW-TO INSTALL

## POOL COPING

There are **THREE** pool types that require different approaches to installation coping.

- VINYL LINER OR FIBERGLASS POOL
- VINYL LINER OR FIBERGLASS POOL WITH RECESSED CONCRETE OVERLAY
- CONCRETE POOL

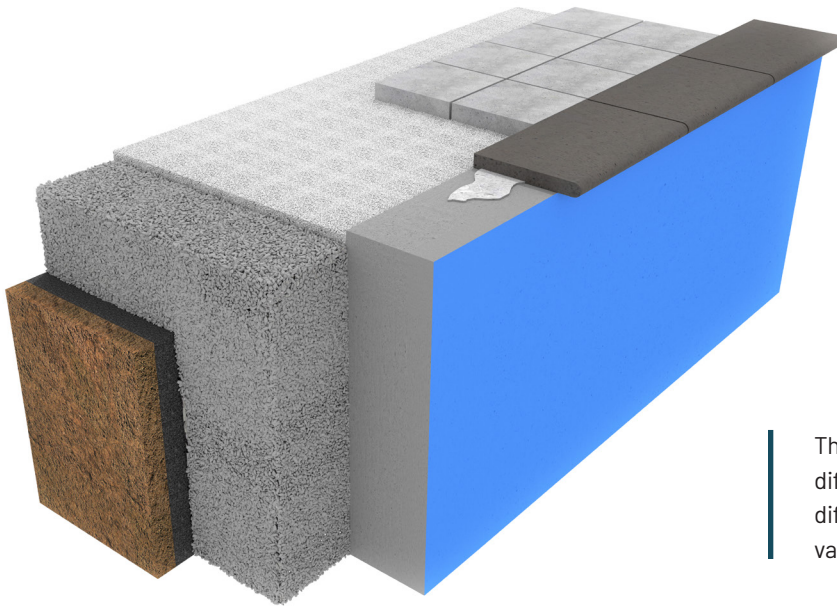

This guide will take you through different methods for these different kinds of pools, as well as various coping types.

# HOW-TO INSTALL

## POOL COPING

➤ Tools and Equipment .....	4
Construction Supplies .....	5
Vinyl Liner or Fiberglass Pool .....	6
Vinyl Liner or Fiberglass Pool Recessed Concrete Overlay.....	7
Concrete Pool .....	8
Coping Types.....	9
90° Corner - Miter Joint.....	10
90° Corner - Tight fit butt joint.....	11
90° Corner - Coined .....	12
Straight Wall Coping.....	13
Curved Wall Coping .....	14
Mitering Coping for Curves .....	15
Adhering the Coping.....	16

# HOW-TO INSTALL

## POOL COPING

### Tools and Equipment



Rubber Mallet



Tape Measure

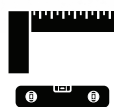

Square and Level



Caulking Gun



Shovel



Rake



Masonry Brush



Fluorescent String Line



Wheelbarrow



5 gallon pail



Mortar mixing Paddle



1/2" Drill for mixing



Mini Excavator



Mini Dumper



Concrete Mixer (Recommended)



Masonry Saw



Vibratory Compactor

# HOW-TO INSTALL

## POOL COPING

### Construction Supplies



Unilock  
Coping



Sonotubes  
(42" Long x 8" Diameter)



1/2" Rebar for  
reinforcement



Joint  
Grout Mix



Redi-Mix  
concrete /  
bagged  
concrete mix



2 x 6 Framing  
Lumber and  
Stakes



Duct  
Tape



Concrete  
Adhesive

# HOW-TO INSTALL

## POOL COPING

### Vinyl Liner or Fiberglass Pool

Vinyl Liner and Fiberglass are the most common pool types. The method for installing pool coping is basically the same for both.

#### STEP 01

Frame and pour a reinforced concrete collar around the perimeter of the pool. Minimum size should be 6 x 6 x 6" (150 x 150 x 150mm).

#### STEP 02

Ensure the top of the collar is recessed 1/2" (12mm) down from the top of pool and troweled to an even surface. Brush finish.

#### STEP 03

Let collar cure for minimum of 3 days.

#### STEP 04

Dry-fit all coping and make appropriate cuts (refer to cutting techniques covered later in this guide).

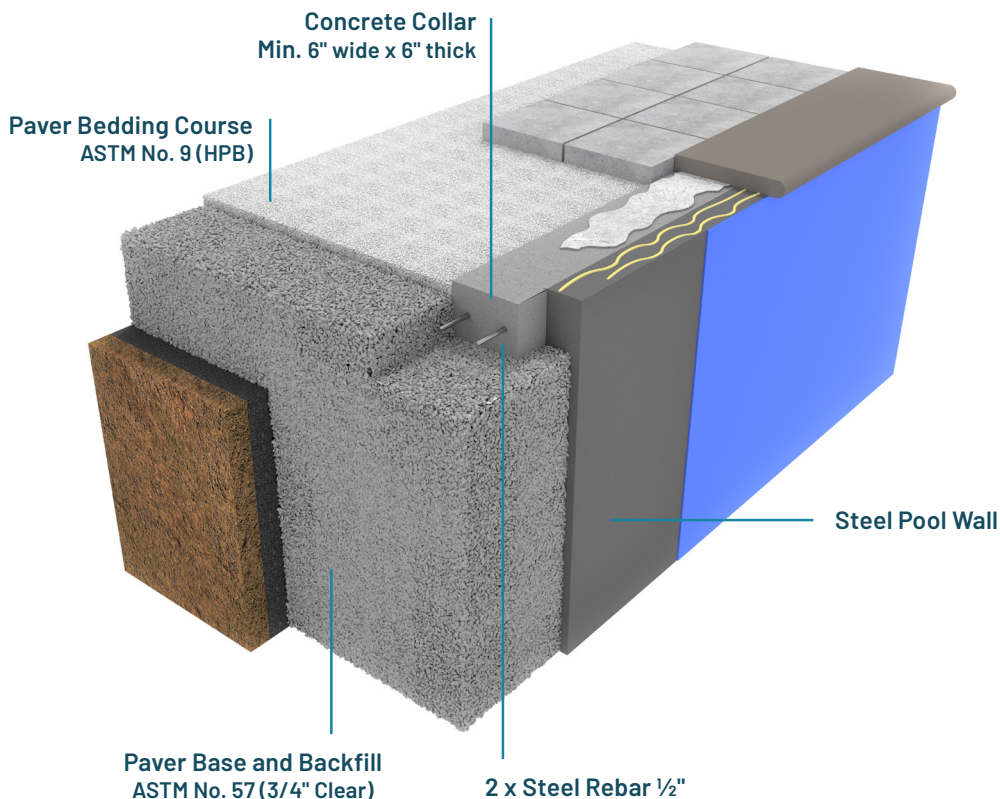

# HOW-TO INSTALL

## POOL COPING

### Vinyl Liner or Fiberglass Pool with Recessed Concrete Overlay

This method is very similar to the previous method with the exception of an additional concrete underbase over which pavers can be placed to eliminate any possibility of paver settlement.

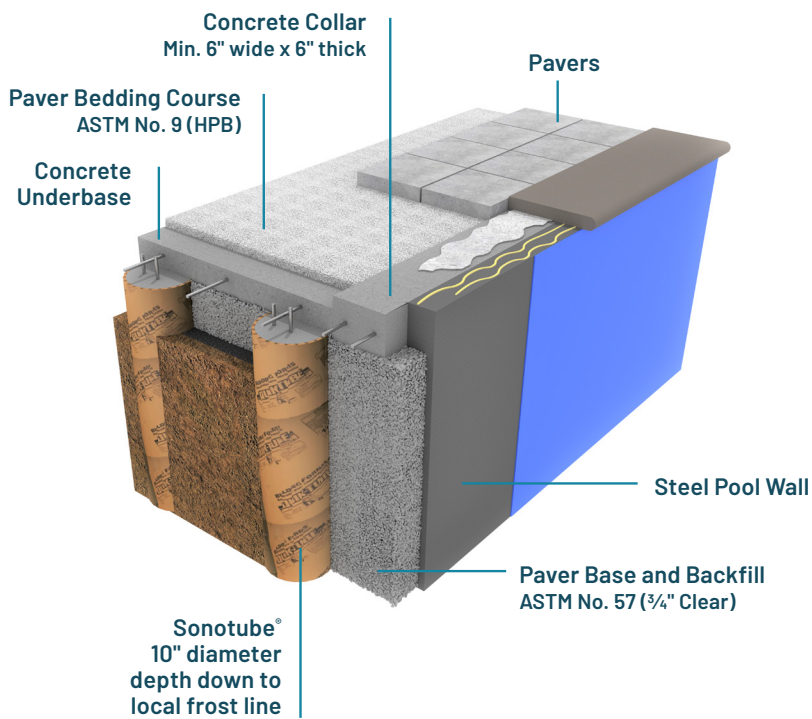

#### STEP 01

Frame the concrete collar form to accommodate 1/2" (12mm) mortar between it and the coping.

#### STEP 02

Frame the concrete underbase at least 4" (200mm) thick and provide enough recess from top of collar to underbase surface to accommodate the paver thickness plus 1" of HPB (ASTM No. 57) bedding material. You may eliminate the 1" of bedding if you are installing the pavers directly over the concrete in which case you must ensure that the surface is troweled to an accurate fine finish. NOTE: Direct concrete overlays will not allow paver surface leveling with a tamper to remove height variances.

#### STEP 03

Reinforce the concrete underbase with 1/2" (12mm) rebar and support it on Sonotubes spaced at 4 ft intervals.

#### STEP 04

Ensure that the underbase slopes away from the pool edge approximately 2%.

#### STEP 05

Dry-fit all coping and make appropriate cuts (refer to cutting techniques covered later in this guide).

# HOW-TO INSTALL

## POOL COPING

### Concrete Pool

This is the easiest method since the pool wall provides the structural support for the coping units.

#### STEP 01

Scarify (roughen up) the top of the pool's concrete wall. This will ensure good adhesion of the mortar and the coping.

#### STEP 02

Dry-fit all coping and make appropriate cuts (refer to cutting techniques covered later in this guide).

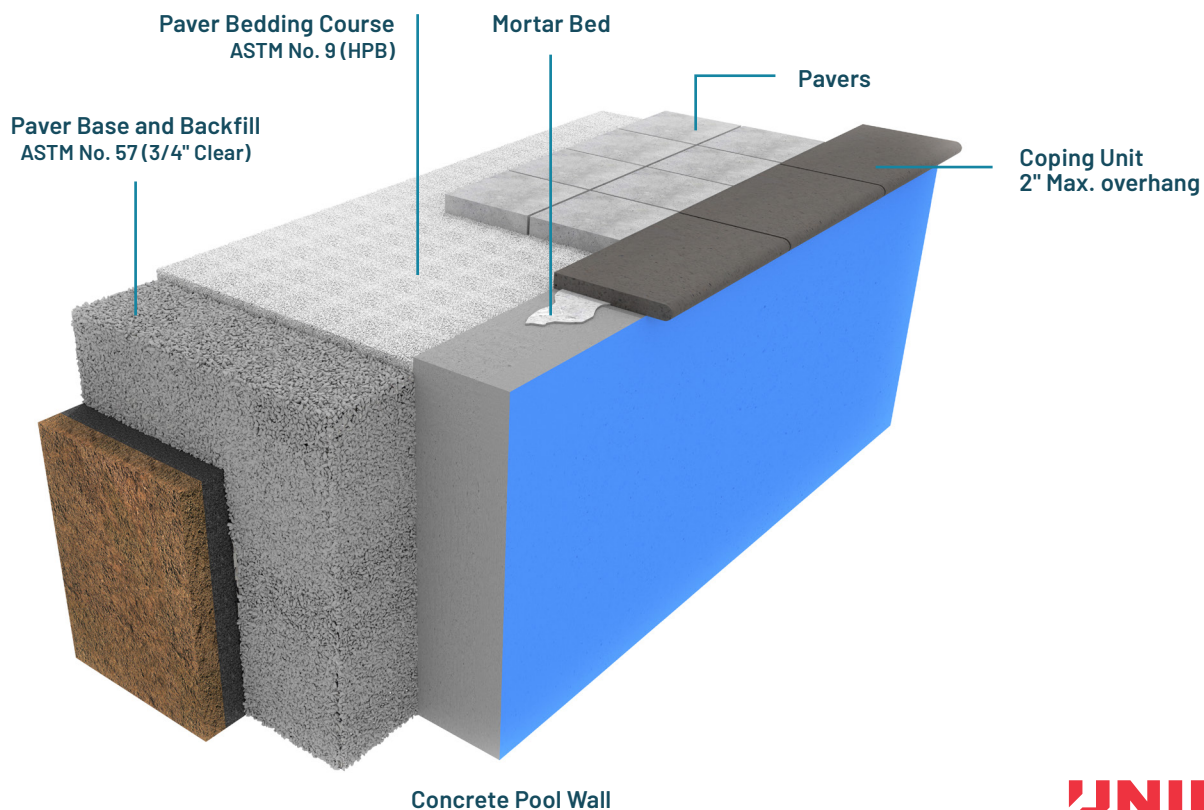

# HOW-TO INSTALL

## POOL COPING

### Coping Types

There are many manufactured and natural stone coping options to choose from. Longer units tend to be for straight designs and shorter units used for curvilinear pool designs.

Some designs also are more suited to mortar joints instead of tight fitting butt joints. **Butt joints are more work** when it comes to cutting but time is saved because there are no mortar joints. **Mortar joints can make things easier** by allowing you to fine tune spacing on radius projects. Mortar joints also provide added visual texture.

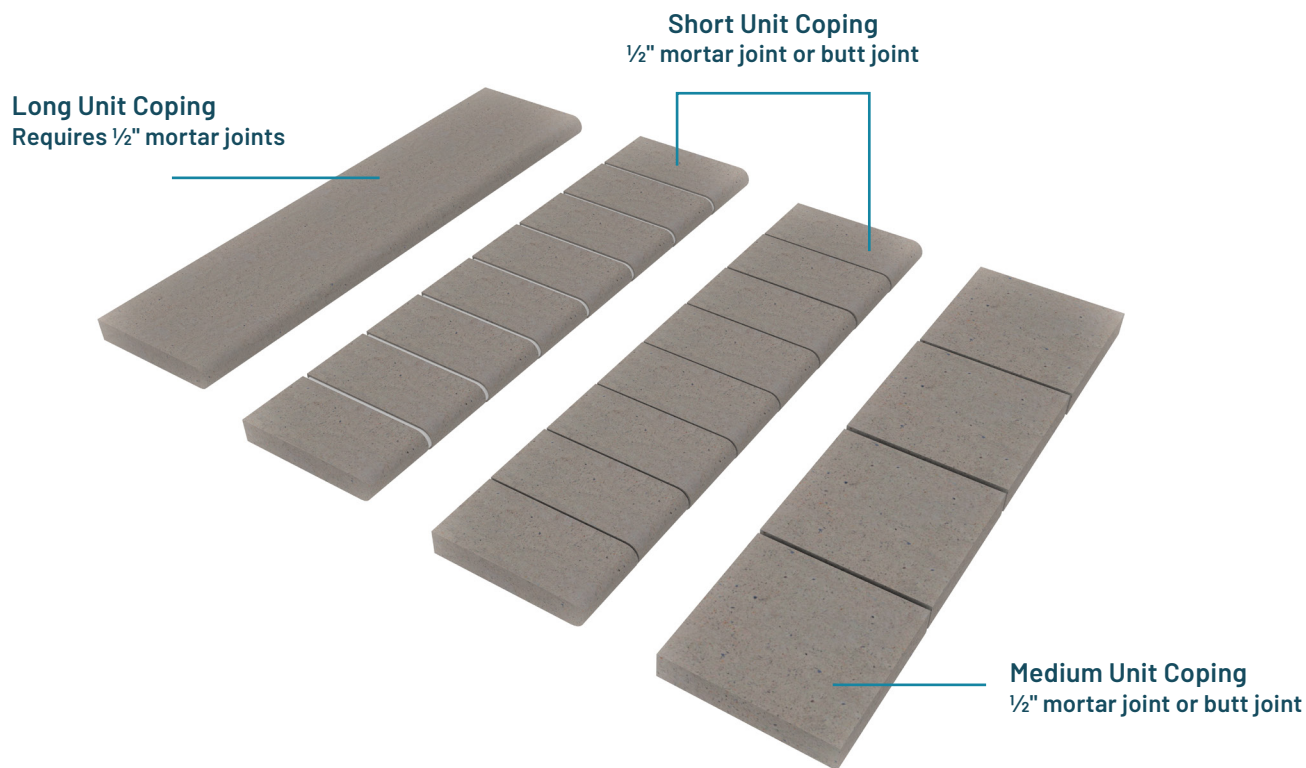

# HOW-TO INSTALL

## POOL COPING

### 90° Corner - Miter Joint

Miter cuts are generally the preferred cut as they result in the best appearance. However, making miter cuts can be tricky and may take several tries for inexperienced hardscapers. Practicing on remnants and waste material is a good idea until your technique is refined. Accurate measurements are the key to a successful cut.

- **Important:** Make all your 90° corners before installing the rest of the coping around the pool.
- Use a hand held masonry saw or a wet masonry table saw. Wet masonry table saws are the most accurate.
- If your plan is to use a grouted joint, your cuts can be slightly more forgiving. Allow 1/4" between units for the grout.
- For tight joints, you may need a small grinder with a diamond blade to fine tune the edge.

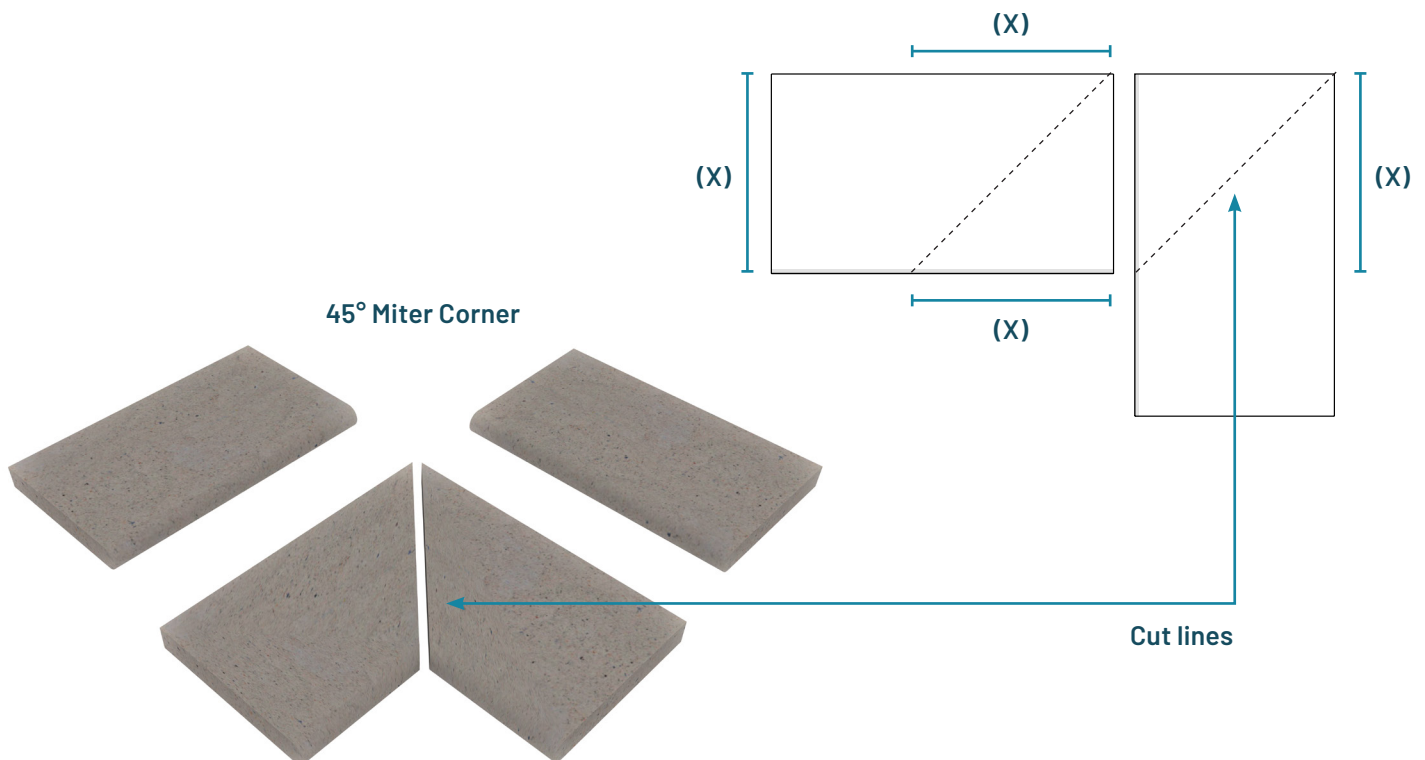

# HOW-TO INSTALL

## POOL COPING

### 90° Corner - Tight fit butt joint

A tight fit butt joint is easier to fit than a mitered joint, so it's often used by less experienced installers. A butt joint also avoids the long points of a mitered joint which can get damaged while cutting or during installation.

- **Important:** Always make all your 90° corners before installing the rest of the coping around the pool.
- Depending on the style of coping, tight fit butt joints may require an indentation cut to one unit to accommodate the end of the opposing unit.
- A handheld saw along with the help of a small hand grinder will make this easy. Always practice on scrap pieces.
- A flexible grout is recommended between all coping joints with ¼" spacing between units. If your plan is to have ½" (12mm) mortar joints, then your cuts can be modified slightly to accommodate the spacing. Apply grout between units before sliding them together.

#### 90° Butt joint corner

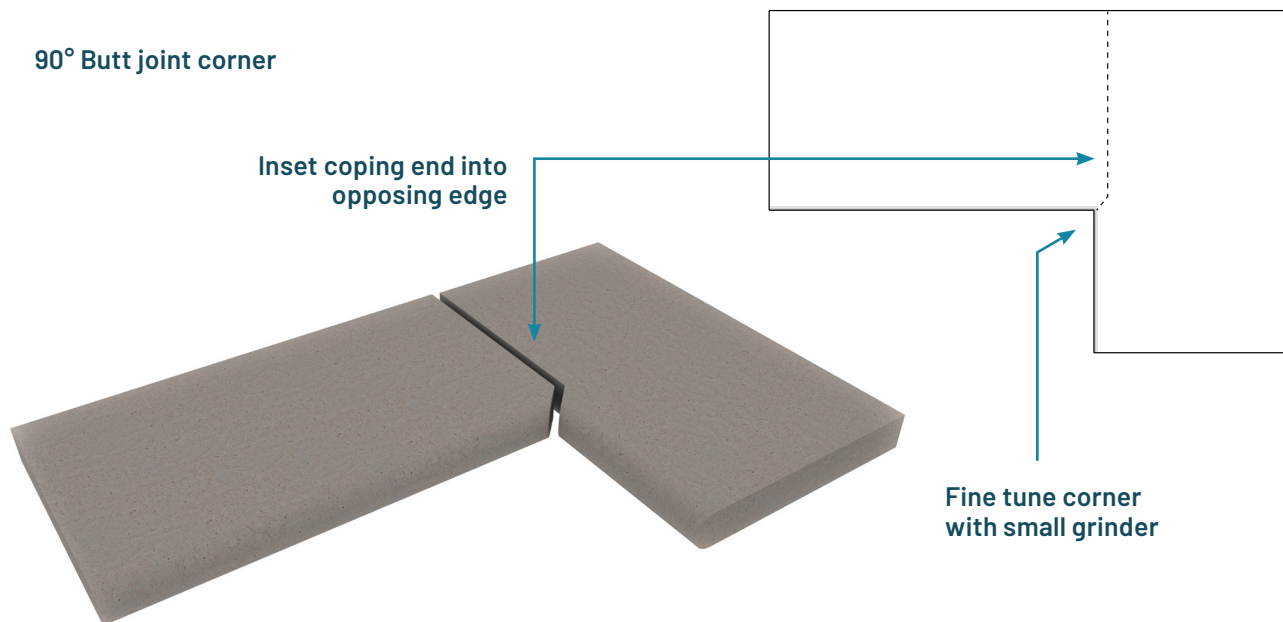

# HOW-TO INSTALL

## POOL COPING

### 90° Corner - Coined

Coining a corner is by far the easiest way to construct a corner and saves cutting. Choosing a different color or texture for the “coin”, can add visual interest.

➤ **Important:** Install all your 90° corners before installing the rest of the coping around the pool.

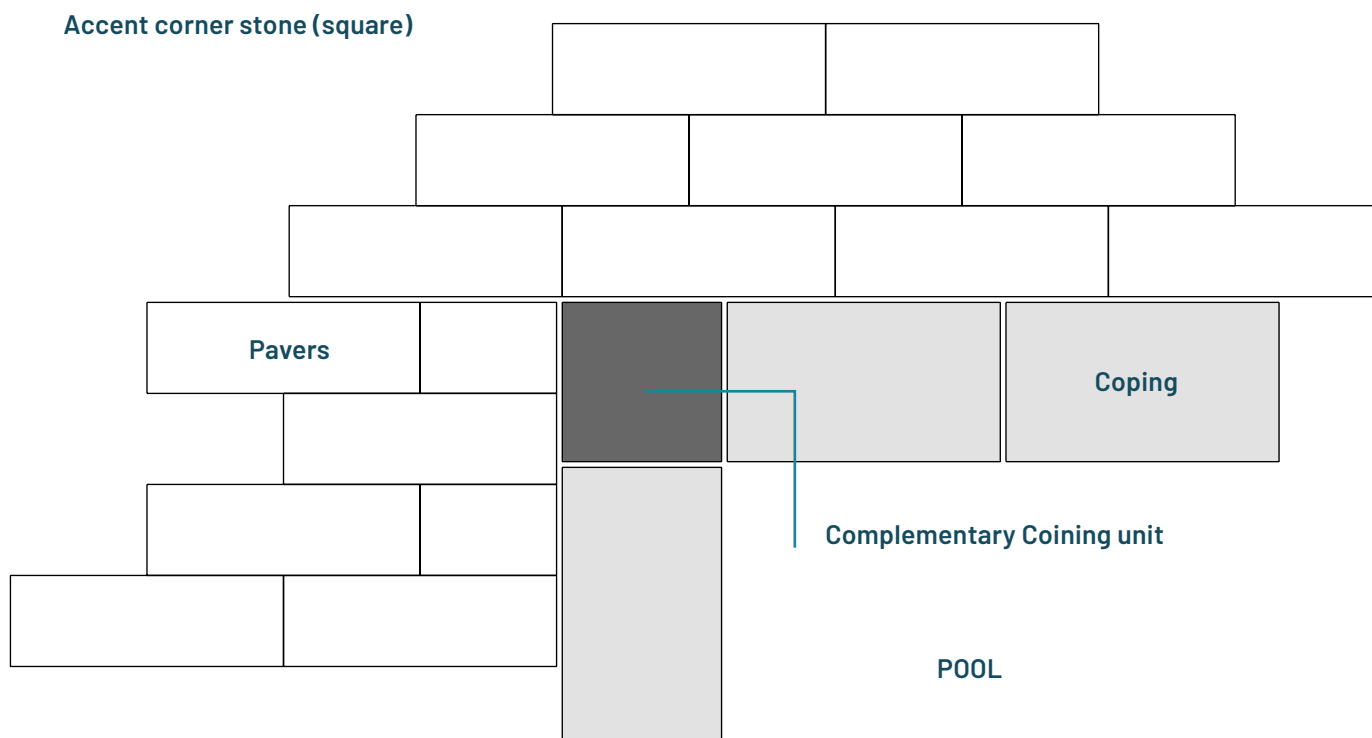

# HOW-TO INSTALL

## POOL COPING

### Straight Wall Coping

- ◇ Longer units install faster and look better. Maximum recommended length is 72" (1.8m)
- ◇ Shorter units install slower but are generally less expensive.
- ◇ A tight fit butt joint is easier to fit than a mitered joint, so it's often used by less experienced installers.
- ◇ Always install corners first and then fill in up to corners.
- ◇ Dry fit your coping first and work out cuts strategically to avoid short awkward cuts and unbalanced lengths that are not visually pleasing.
- ◇ Think about balance prior to ordering coping units. In the example below there are 2 lengths that must be ordered for a balanced install. 8 pieces x 48" and 12 pieces x 72".
- ◇ Always order units that are longer than you need to give you some flexibility.

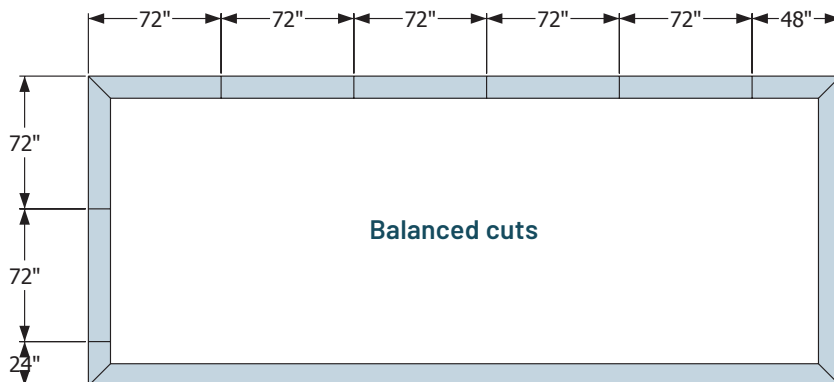
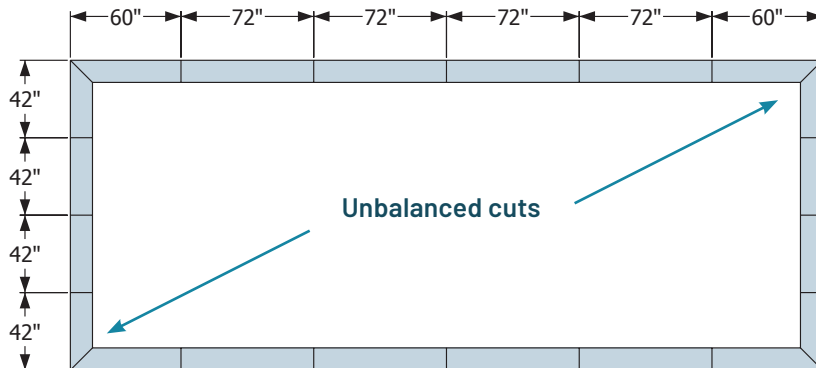

# HOW-TO INSTALL

## POOL COPING

### Curved Wall Coping

Mitering coping units around curved pools is a combination of mathematics and art. Whether you are planning a mortar joint or a tight fit joint, you may need to miter some or all of the coping units. This illustration shows 12 x 12" (30 x 30cm) coping units. The same process applies regardless of the size of the coping units.

➤ **Note:** Shorter coping units will "flow" better and not look choppy. Avoid units longer than 18" (45cm) for radius pools.

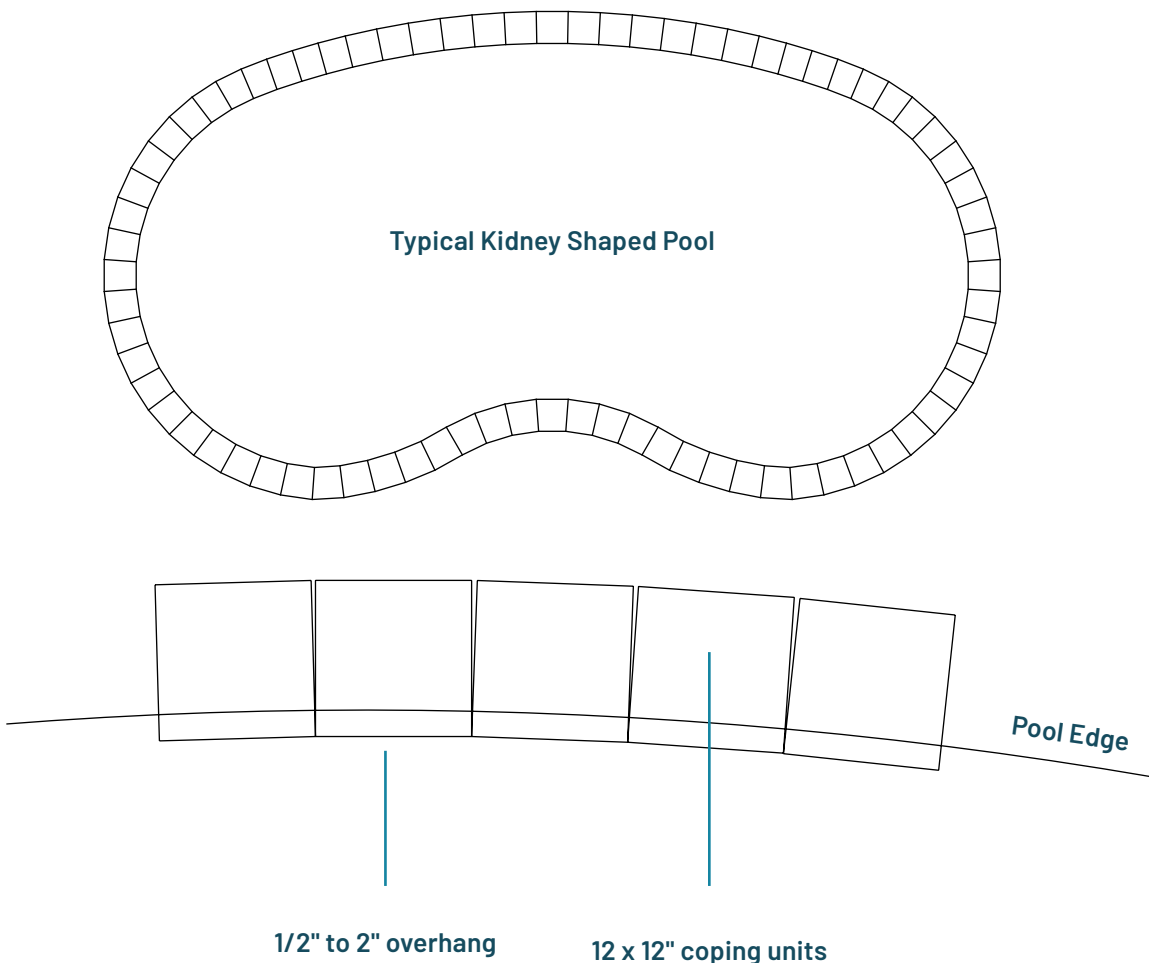

# HOW-TO INSTALL

## POOL COPING

### Mitering Coping for Curves

#### STEP 01

Dry lay 3 or 4 coping units along the pool edge so that the front edges or back edges are touching depending the curvature. (See diagram below).

#### STEP 02

Overhang the units over pool wall by approximately 2".

#### STEP 03

Using a straightedge such as a level or square, mark two parallel lines over the gap to be mitered.

#### STEP 04

Cut using a hand-held masonry saw or a wet masonry table saw.

#### STEP 05

Check to make sure the units fit well and then proceed to the next batch of 3 or 4 units until complete.

➤ **Tip:** For tight fit installation you can "perfect" a joint by running the masonry saw between two adjacent units which are touching. This creates a perfect fit every time. (Be careful not to cut the pool wall below)

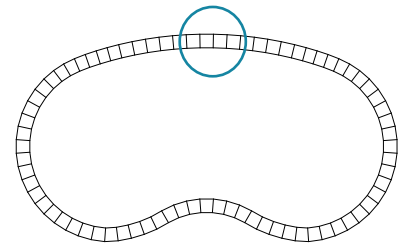
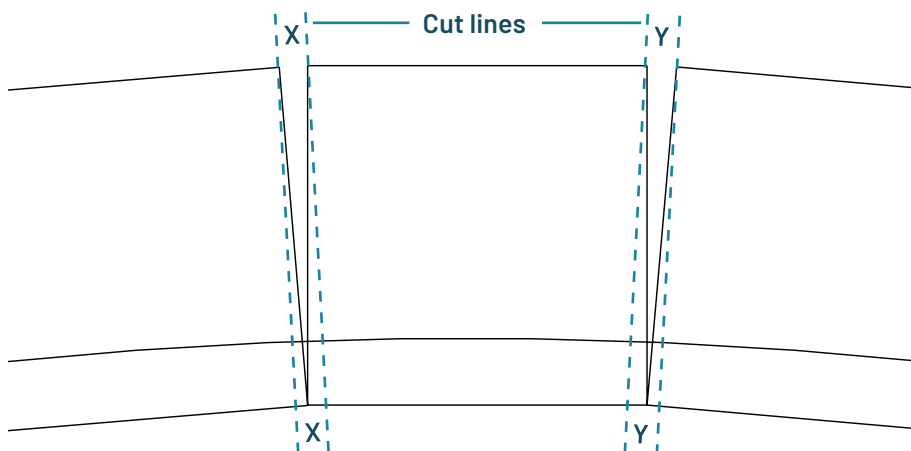

# HOW-TO INSTALL

## POOL COPING

### Adhering the Coping

Adhere coping to the pool perimeter with concrete adhesive between the coping and the pool wall, and a bed of mortar between the concrete collar and the remaining of the coping's underside. The mortar bed allows you to tweak the slope of each unit, while the concrete adhesive will provide longevity of the installation.

#### STEP 01

Ensure the coping is clean.

#### STEP 02

For straight sided pools, always construct the corners first and work towards the middle. This way you can make cuts to adjust lengths where required.

#### STEP 03

Use a modified mortar such as Ardex X32 or X37 to adhere units to the concrete collar, and always follow the manufacturer's instructions. Apply the mortar using a 1/4" notched trowel. Pre-wetting the concrete collar and using a slightly wetter mix of mortar will help units adhere better.

#### STEP 04

Coping should overhang approximately 2" (50mm) and slope at a 2% grade away from the pool. Use a string line to maintain straightness and a torpedo level to maintain the slope of each unit.

#### STEP 05

Do not let grouting mortar cure on surface of the coping. Always clean any mortar residue off the surface of the coping and adjacent pavers with a soft brush, warm water and a sponge as you go. Fill the joints between units with an exterior tile grout.

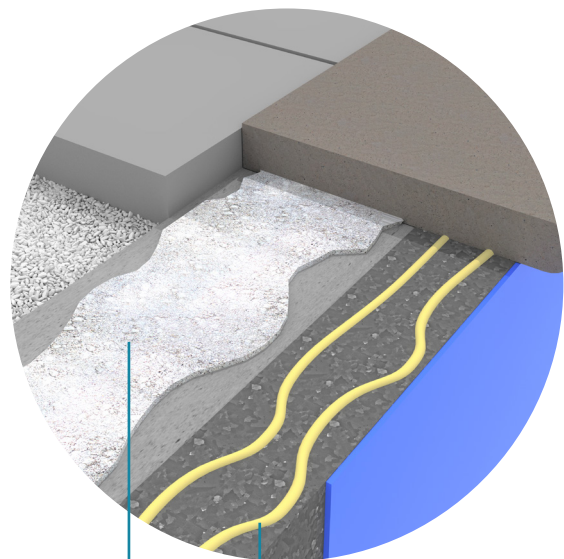

Mortar Bed

Concrete Adhesive

# HOW-TO **INSTALL**

## **POOL COPING**

**Congratulations - your pool coping is complete!**

For more help designing and building pool projects, contact your local Unilock Territory Manager (1-800-UNILOCK) to arrange a phone consultation or site visit.

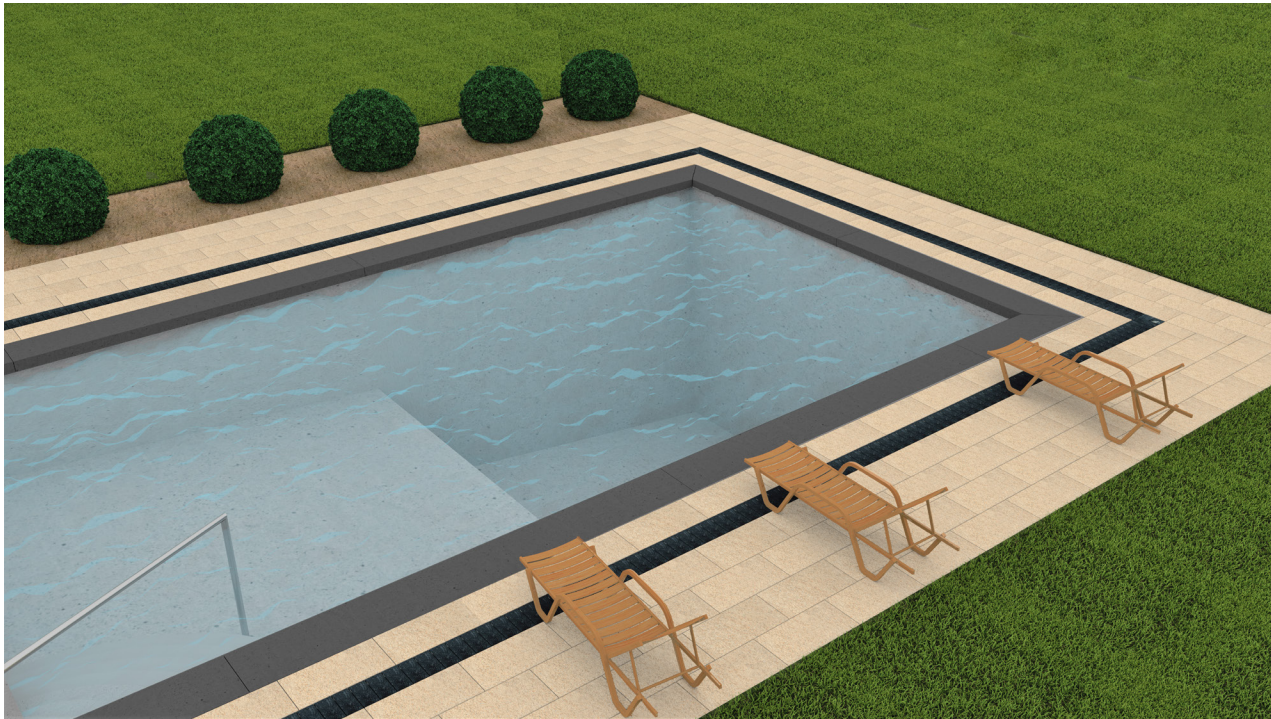

Completed pool project

## Hardscape Education Center

Looking for more product specific information?

The **Unilock Hardscape Education Center** contains a robust library of **over 1,500...**

- › Cross Sections
- › Instructional Videos
- › Seminar Recordings
- › Catalog Downloads
- › Certificate Courses

You can access all this and more in the contractor section of **Unilock.com**.

